

Field Guide

F3 Detector

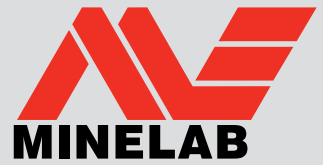

Operation

1.

Switch On

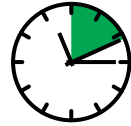
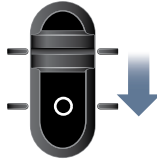
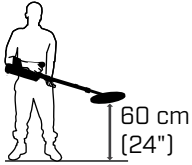

12 seconds



2.

Ground Balance

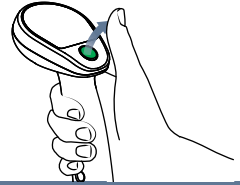
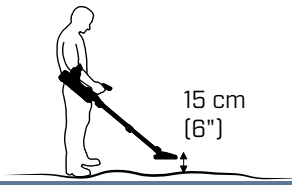
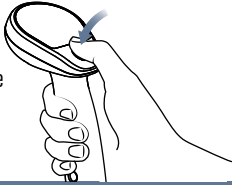

3.

Test Piece

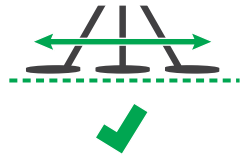
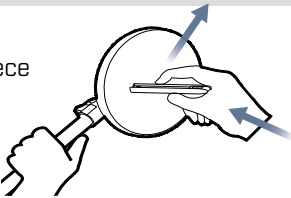

4.

Audio Reset

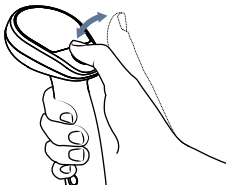

5.

Noise Cancel

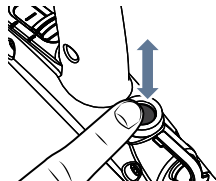
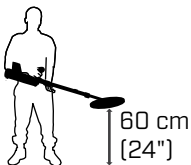
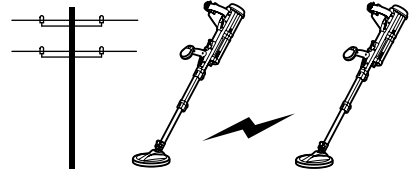

45 seconds



F3 Configuration

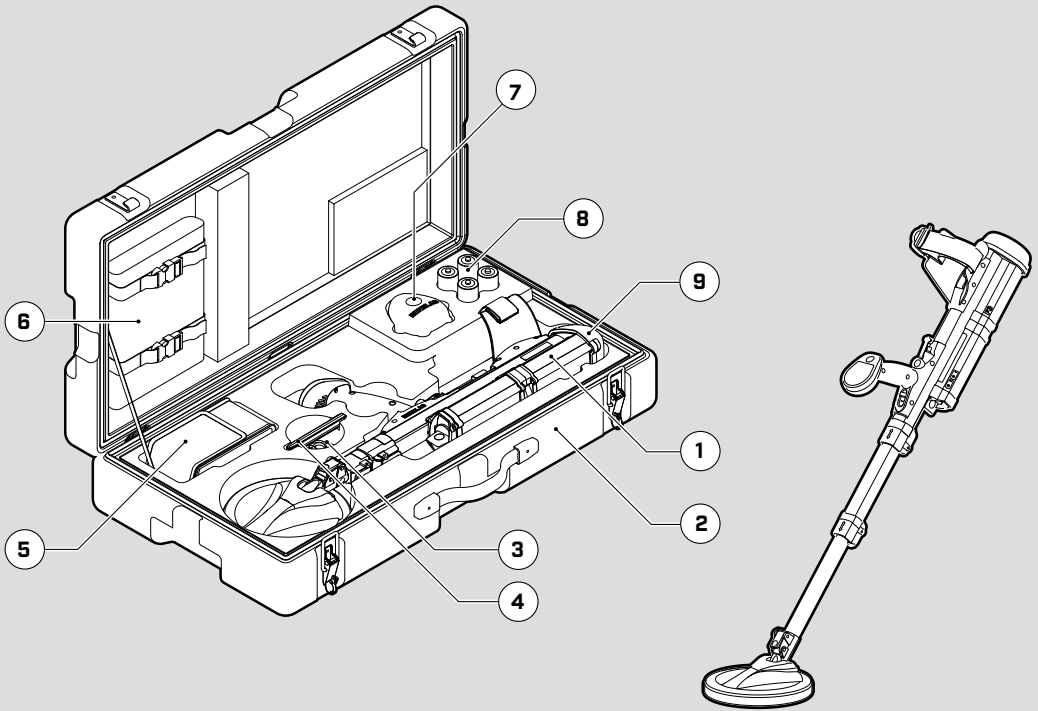

- | | |
|--|--|
| 1. F3 Detector | 5. Battery Pack Bag and Extension Cable (Optional) |
| 2. Field Guide and Operations Manual (Underneath detector) | 6. Soft Carry Bag |
| 3. Earset (Underneath Test Piece) | 7. Red Endcap (Low Sensitivity F3) |
| 4. Test Piece | 8. Batteries 4 × D Cell |
| | 9. Black Endcap (High Sensitivity F3) |



Black
High Sensitivity
(Default
Endcap)



Red
Reduced
Sensitivity



Yellow
Detector Settings
Customisable
Via PC